

Support wheels

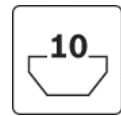

- Support roller for constructing trolleys or roller sections
- Mounted on profiles with 10 mm slot
- Good running characteristics thanks to deep-groove ball bearing with large diameter
- Support roller with rim can be guided in 10 mm slot
- ESD-conductive

Product description

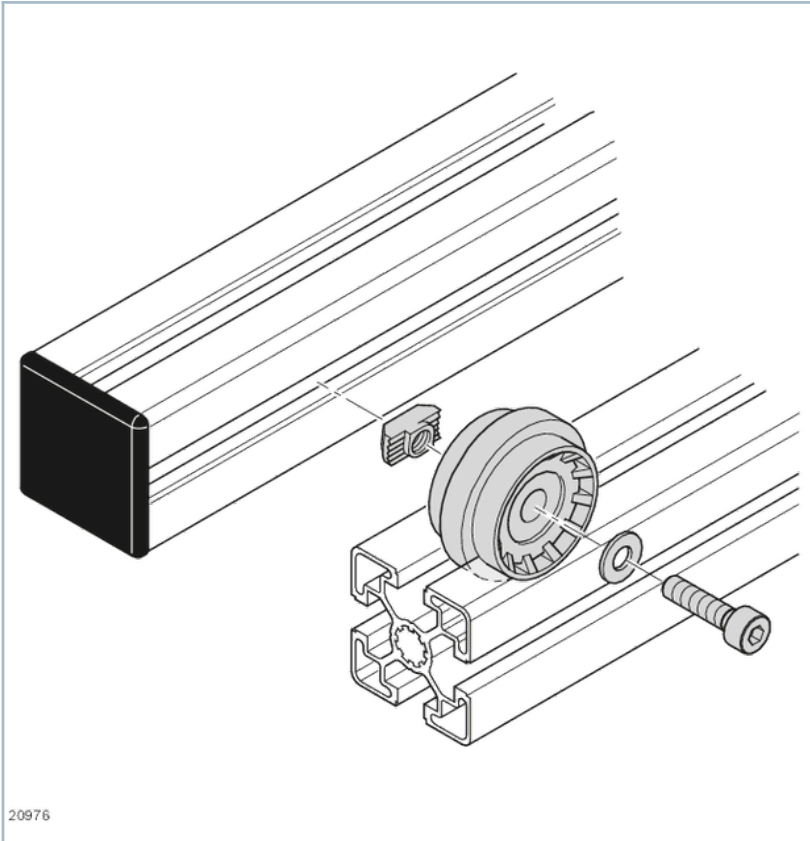

Technical data

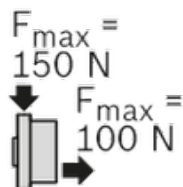
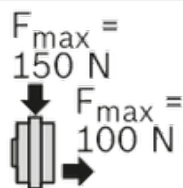
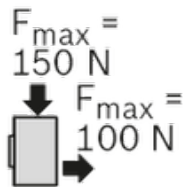

Dimensions

Support rollers with center rim

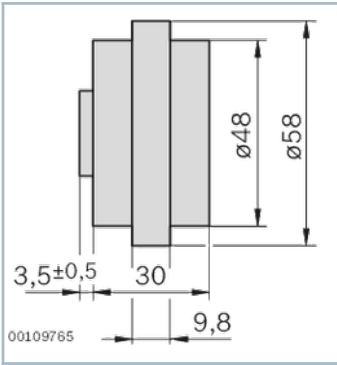

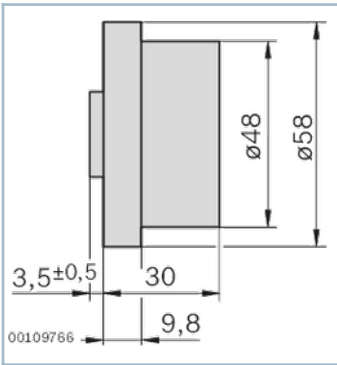

Support rollers with side rim

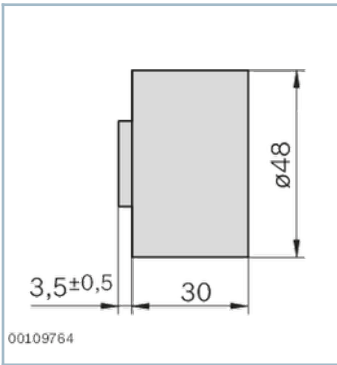

Support roller



Ordering codes

	ESD	FS	No.
Support rollers with center rim		FS1	3842218940
Support rollers with side rim		FS1	3842218941
Support roller		FS1	3842218942